



# baldes de lixo





MOD. 40-45-50



MOD. 60



MOD. 70-80



MOD. 90

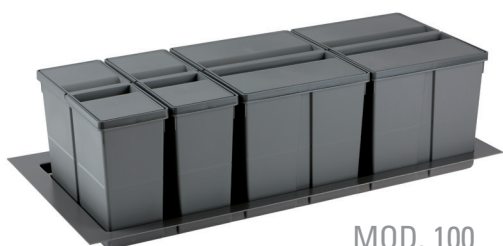



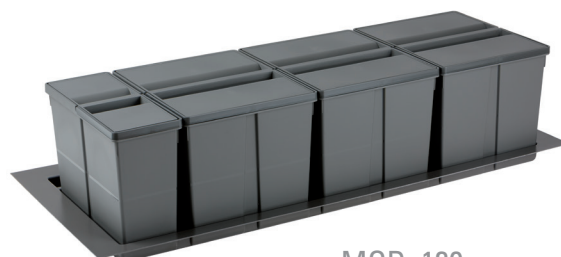















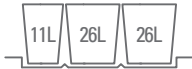

MOD. 100



MOD. 120

**BALDES DE GAVETÃO**

|                      | TAB.         | REFERÊNCIA       | ALTURA     | CAPACIDADE   |  TABULEIRO MIN./MAX.  |
|----------------------|--------------|------------------|------------|--|--|
| <b>MOD. 40-45-50</b> | <b>C2.1</b>  | 9XL BASE 404550A | ↑ 277 Alt. |    | <br>     |
|                      | <b>C2.2</b>  | 9XL BASE 404550B | ↑ 207 Alt. |    |  |
| <b>MOD. 60</b>       | <b>C2.3</b>  | 9XL BASE 600A    | ↑ 277 Alt. |    | <br>     |
|                      | <b>C2.4</b>  | 9XL BASE 600B    | ↑ 207 Alt. |    |  |
| <b>MOD. 70-80</b>    | <b>C2.5</b>  | 9XL BASE 800A    | ↑ 277 Alt. |    | <br>     |
|                      | <b>C2.6</b>  | 9XL BASE 800B    | ↑ 207 Alt. |    |  |
| <b>MOD. 90</b>       | <b>C2.7</b>  | 9XL BASE 900A    | ↑ 277 Alt. |    | <br>   |
|                      | <b>C2.8</b>  | 9XL BASE 900B    | ↑ 207 Alt. |   |  |
| <b>MOD. 100</b>      | <b>C2.9</b>  | 9XL BASE 1000A   | ↑ 277 Alt. |  | <br> |
|                      | <b>C2.10</b> | 9XL BASE 1000B   | ↑ 207 Alt. |  |  |
| <b>MOD. 120</b>      | <b>C2.11</b> | 9XL BASE 1200A   | ↑ 277 Alt. |  | <br> |
|                      | <b>C2.12</b> | 9XL BASE 1200B   | ↑ 207 Alt. |  |  |

| TAB.         | ARTIGO                            | REF.           | MÓD. |
|--------------|-----------------------------------|----------------|------|
| <b>C2.13</b> |                                   | 9XL COP 600    | 600  |
| <b>C2.14</b> | Tampas*                           | 9XL COP 800    | 800  |
| <b>C2.15</b> | (fixação lateral com 25mm altura) | 9XL COP 900    | 900  |
| <b>C2.16</b> |                                   | 9XL COP 1000   | 1000 |
| <b>C2.17</b> |                                   | 9XL COP 1200   | 1200 |
| <b>C2.18</b> | Tampa para Spray                  | 9XL COP SPRAY  | /    |
| <b>C2.19</b> | Líquido - 1000ml.                 | 9XL LIQ 1000ML | /    |
| <b>C2.20</b> | KIT Divisórias - 277 Alt.         | 6DIV AG 49XL   | /    |
| <b>C2.21</b> | KIT Divisórias - 207 Alt.         | 6DIV BG 49XL   | /    |

\* Tampas equipadas com sistema de fixação às laterais do módulo.



SPRAY



TAMPAS

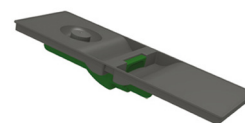

TAMPA PARA SPRAY

DIVISÓRIAS

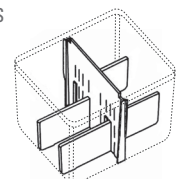

**BALDES DE EXTRACÇÃO FRONTAL**

**580 PLUS LINE**

| TAB.  | REF.       | CAPAC.         | MÓD. | PROF. | ALT. |
|-------|------------|----------------|------|-------|------|
| C2.22 | 580 PL 30C | 40l.           | 300  | 458   | 505  |
| C2.23 | 580 PL 40A | 2x 29l.        | 400  | 458   | 463  |
| C2.24 | 580 PL 45A | 2x 29l.        | 450  | 458   | 463  |
| C2.25 | 580 PL 50C | 2x 40l.        | 500  | 458   | 505  |
| C2.26 | 580 PL 60C | 2x 40l.        | 600  | 458   | 505  |
| C2.62 | 580 PL 60A | 2x8l. + 2x29l. | 600  | 458   | 463  |

» Balde de fixação à porta.

**G\*GRASS**  
EXTRAÇÃO 100%

→  
Soft Closing



Mod. 300



Mod. 400



Mod. 450



Mod. 500



Mod. 600



Mod. 600  
2x8l. + 2x29l.

| TAB.  | ARTIGO   | REF.     | MÓD. |
|-------|----------|----------|------|
| C2.27 | Tampas * | 6 COP 30 | 300  |
| C2.28 |          | 6 COP 40 | 400  |
| C2.29 |          | 6 COP 45 | 450  |
| C2.30 |          | 6 COP 50 | 500  |
| C2.31 |          | 6 COP 60 | 600  |

TAMPAS



\* Tampas equipadas com sistema de fixação às laterais do módulo.

**BALDES DE EXTRAÇÃO FRONTAL**



**GLOBE**



| TAB.  | REF.         | CAPAC.  | MÓD. | ARTIGO  |       |      |
|-------|--------------|---------|------|---------|-------|------|
|       |              |         |      | LARG.   | PROF. | ALT. |
| C2.32 | VB_BD_PRT_30 | 36l.    | 300  | 264-268 | 467   | 526  |
| C2.33 | VB_BD_PRT_40 | 2x 20l. | 400  | 364-368 | 467   | 477  |
| C2.34 | VB_BD_PRT_45 | 2x 30l. | 450  | 414-418 | 467   | 477  |
| C2.35 | VB_BD_PRT_50 | 2x 30l. | 500  | 464-468 | 467   | 477  |
| C2.36 | VB_BD_PRT_60 | 2x 36l. | 600  | 564-568 | 467   | 526  |

- » Balde de fixação à porta.
- » Inclui tampa metálica para fixar às laterais do módulo.

**GRASS**  
EXTRAÇÃO 100%

→  
Soft Closing

50kg

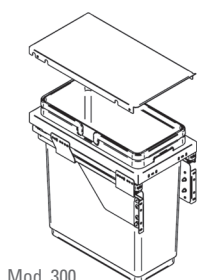

Mod. 300

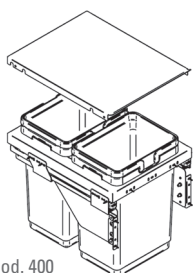

Mod. 400

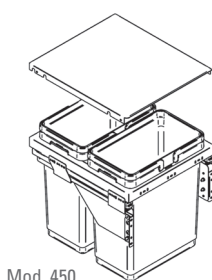

Mod. 450

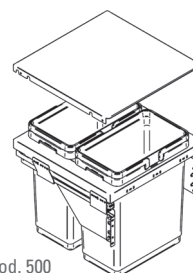

Mod. 500

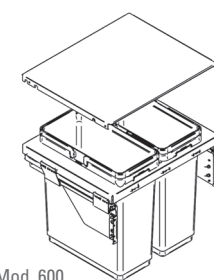

Mod. 600

**BALDES DE EXTRACÇÃO FRONTAL**

**TOP-COMFORT**



**ARTIGO**

| TAB.  | REF.       | CAPAC.      | ILHARGA | MÓD. | PROF. | ALT. |
|-------|------------|-------------|---------|------|-------|------|
| C2.37 | FI-5160.00 | 35L. + 16L. | 16mm    | 600  | 450   | 481  |

» Gaveta BLUM não incluída.

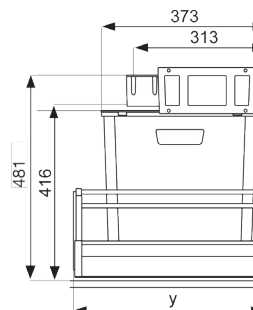
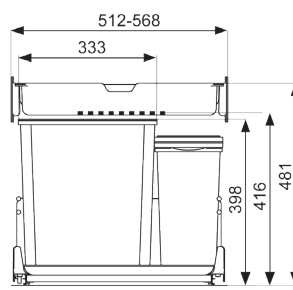

Blum - 450

**COMFORT**



**ARTIGO**

| TAB.  | REF.         | CAPAC.              | MÓD. | PROF. | ALT. |
|-------|--------------|---------------------|------|-------|------|
| C2.38 | FI-35.2.2    | 35L. + 2x2L.        | 400  | 500   | 500  |
| C2.39 | FI-35.17.4.4 | 35L. + 17L. + 2x4L. | 550  | 530   | 500  |

» Abertura automática da tampa, aquando da abertura da porta.

| TAB.  | REF.       | ACESSÓRIOS                     |
|-------|------------|--------------------------------|
| C2.40 | FI-5019.80 | Pedal - Sistema KickMatic      |
| C2.41 | FI-4619.90 | Soft Close - Sistema StopMatic |



FI-35.2.2

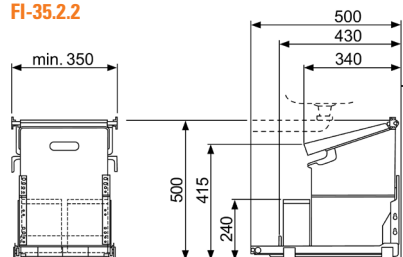

FI-35.17.4.4

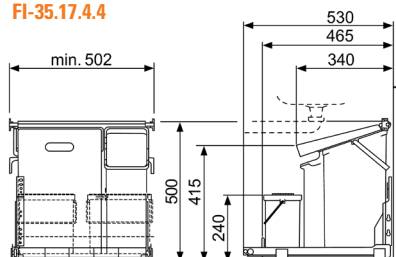

**BALDE DE EXTRACÇÃO FRONTAL**

**SINGLE - REBATÍVEL**



| ARTIGO |            |        |      |       |      |
|--------|------------|--------|------|-------|------|
| TAB.   | REF.       | CAPAC. | MÓD. | PROF. | ALT. |
| C2.42  | FI-4910.35 | 35L.   | 400  | 365   | 480  |

» Abertura automática da tampa, aquando da abertura da porta.

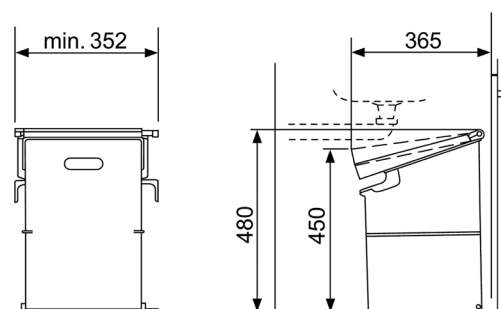

**BALDE GIRATÓRIO PARA PORTA**

**FLEXX**



| ARTIGO |            |        |      |       |         |
|--------|------------|--------|------|-------|---------|
| TAB.   | REF.       | CAPAC. | MÓD. | PROF. | ALT.    |
| C2.43  | FI-4915.35 | 35L.   | 450  | 356   | 470min. |

» Abertura do cesto, aquando da abertura da porta.

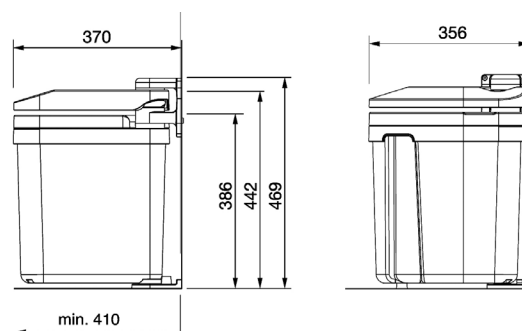

**BALDES DE EXTRAÇÃO FRONTAL**

**LINE 500**



» 511

| TAB.  | REF. | CAPAC.         | ACAB.          | MÓD.       | ARTIGO |       |      |
|-------|------|----------------|----------------|------------|--------|-------|------|
|       |      |                |                |            | LARG.  | PROF. | ALT. |
| C2.44 | 511  | 2x21L.         | Inox           | 400' / 450 | 343    | 477   | 435  |
| C2.45 | 538  | 21L. + 2x9,5L. | Plástico Cinza |            |        |       |      |
| C2.63 | 516  | 2x16L.         | Plástico Cinza |            | 343    | 477   | 372  |

» Abertura automática da tampa.

1. No caso de extração manual (sem sistema de abertura automática), o produto também pode ser fixado num módulo 400mm.



» Sistema de abertura automática.



» 538



» 516



\* Com divisória amovível incluída.

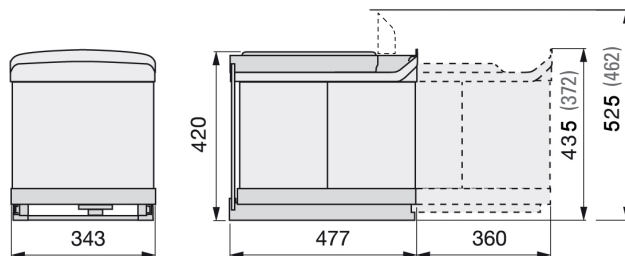



**BALDES DE EXTRACÇÃO FRONTAL**

**LINE 222**



» Tampas amovíveis.

| TAB.  | REF.           | CAPAC.         | ACAB.             | MÓD. | ARTIGO |       |      |
|-------|----------------|----------------|-------------------|------|--------|-------|------|
|       |                |                |                   |      | LARG.  | PROF. | ALT. |
| C2.46 | 224            | 30L.           | Plástico<br>Cinza | 300  | 255    | 450   | 398  |
| C2.47 | 291            | 2x16L.         |                   | 400  | 355    | 450   | 339* |
| C2.48 | 291 FIX. PORTA | 2x16L.         |                   |      |        |       |      |
| C2.49 | 292            | 16L. + 2x7,5L. |                   |      |        |       |      |

» Baldes de extracção TOTAL.

\* Ideal para instalar por baixo do lava-loiça.



» 292



» 291



» 224



» 291 FIX PORTA

**BALDES DE EXTRACÇÃO FRONTAL**

**LINE 227**



| TAB.  | REF. | CAPAC. | ACAB.          | MÓD. | ARTIGO |       |      |
|-------|------|--------|----------------|------|--------|-------|------|
|       |      |        |                |      | LARG.  | PROF. | ALT. |
| C2.50 | 226  | 21L.   | Plástico Cinza | 300  | 255    | 450   | 398  |
| C2.51 | 227  | 2x14L. |                |      |        |       |      |



» Abertura automática da tampa.

» 226

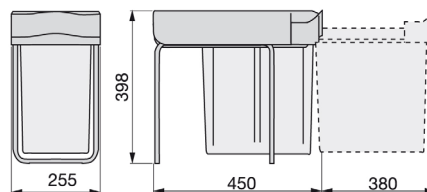

» 227

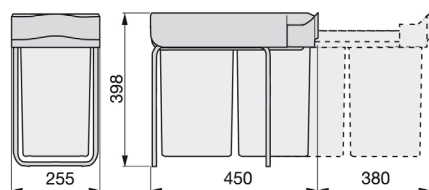

**BALDES DE EXTRACÇÃO FRONTAL**

**LINE 280**



» Pormenor das tampas.



| TAB.  | REF. | CAPAC.  | ACAB.          | MÓD.     | ARTIGO |       |      |
|-------|------|---------|----------------|----------|--------|-------|------|
|       |      |         |                |          | LARG.  | PROF. | ALT. |
| C2.52 | 280  | 16L.    | Plástico Cinza | 300 Min. | 230    | 380   | 360  |
| C2.53 | 281  |         | Inox           |          |        |       |      |
| C2.54 | 283  | 2x7,5L. | Plástico Cinza |          |        |       |      |

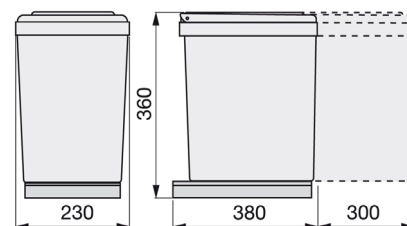

» Abertura automática da tampa.

**BALDE GIRATÓRIO PARA PORTA**

**RING**

**ellelippi**  
1 9 5 4



10L.

**ARTIGO**

| TAB.  | REF.     | CAPAC. | ACAB. | MÓD. | PROF. | ALT. |
|-------|----------|--------|-------|------|-------|------|
| C2.55 | PP 602/4 | 10L.   | Cinza | 400  | 250   | 320  |

» Abertura automática da tampa, aquando da abertura da porta.

**LINE 270**



13L.

| TAB.  | REF. | CAPAC. | ACAB.          | MÓD. | ALT. |
|-------|------|--------|----------------|------|------|
| C2.56 | 270  | 13L.   | Cinza Metálico | 400  | 355  |
| C2.57 | 272  |        | Inox           | Min. |      |



» 272

**BIG-BOX**



15L.

**ARTIGO**

| TAB.  | REF.    | CAPAC. | ACAB. | TAMPA    | MÓD. | PROF. | ALT. |
|-------|---------|--------|-------|----------|------|-------|------|
| C2.58 | 3715-10 | 15L.   | Inox  | Castanho | 400  | 284   | 320  |

**BALDES DE EXTRACÇÃO FRONTAL****EKKO**

| ARTIGO |           |              |      |       |         |      |
|--------|-----------|--------------|------|-------|---------|------|
| TAB.   | REF.      | CAPAC.       | MÓD. | LARG. | PROF.   | ALT. |
| C2.59  | EKKO 9004 | 2x16L.       |      |       |         |      |
| C2.60  | EKKO 9005 | 2x8L. + 16L. | 400  | 355   | 473/910 | 365  |
| C2.61  | EKKO 9006 | 4x8L.        |      |       |         |      |